

Phoenix

DESIGNED FOR YOU

Technical Data Sheet

Range:	Shower Trays
Type:	Rectangular - Centre Waste
Code:	LP016
Version/Date:	v1 06/17

Size	Code	A	B	D	E	F
120 x 76	LP016	120	76	6.5	19	60

Dimensions in CM.

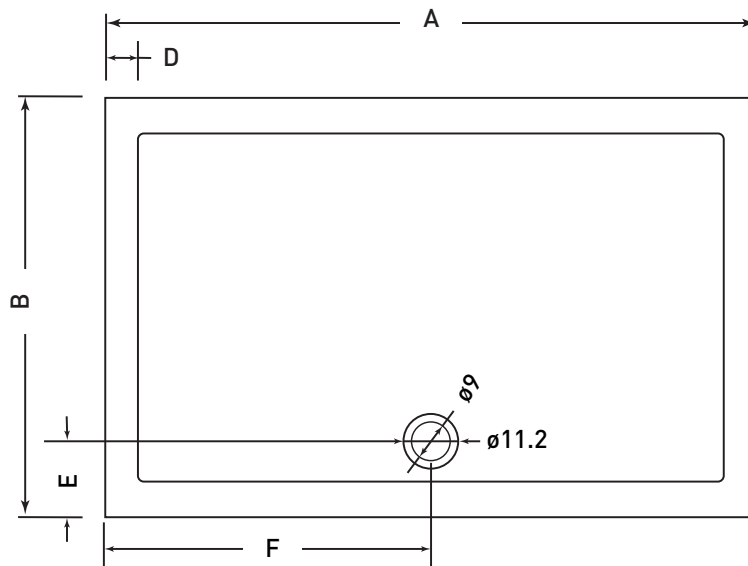

Information: Trays include 90mm waste

Finishes:



Stone Resin

Guarantee/Aftercare: During installation extra care must be taken to avoid damaging the fittings. We provide a guarantee against faulty manufacture or materials (excluding serviceable parts), providing they have been installed, cared for and used in accordance with our instructions and good plumbing practice.

Phoenix Whirlpools Ltd. Unit 8, Leeds 27 Industrial Estate, Bruntcliffe Ave. Morley, Leeds LS27 0LL

Tel: (Sales) +44 (0)113 2012260 Fax: +44 (0)113 2012268 Email: sales@phoenix-uk.co.uk Web: www.phoenix-uk.co.uk

Notes: Drawings may not be to scale. All dimensions in cm unless otherwise stated. Information correct at time of printing but subject to change at any time.