

Range: Ambulant Collection - accessories

Type: Hand grab rail

Code: GR002

Version/Date: v1

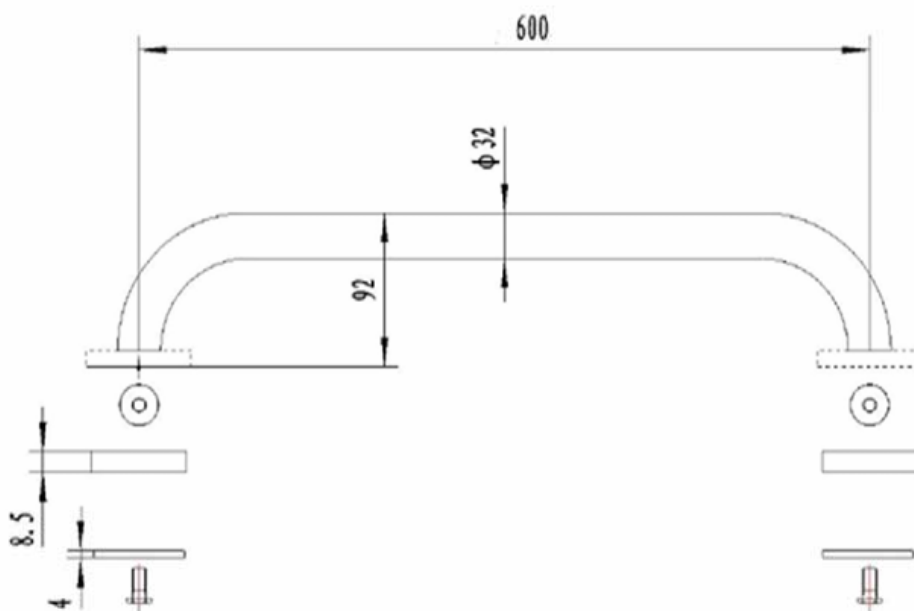
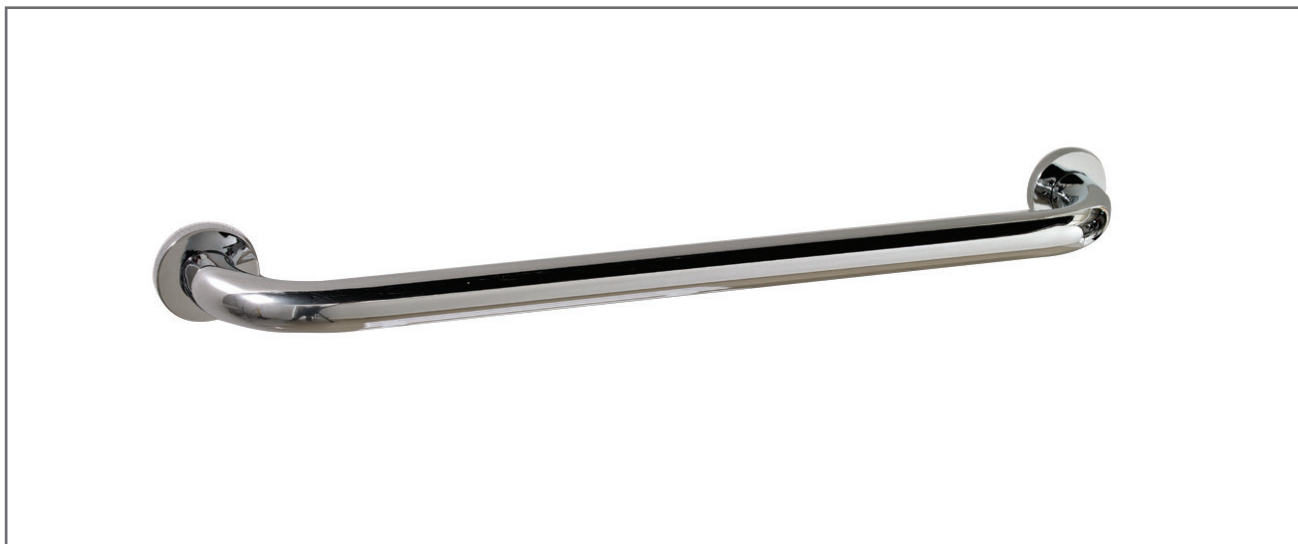

Information:

Stainless Steel  
H:60 x W:600 x D:90  
Diameter 30mm

Finishes:



Chrome

Guarantee/Aftercare: During installation extra care must be taken to avoid damaging the fittings. We provide a guarantee against faulty manufacture or materials (excluding serviceable parts), providing they have been installed, cared for and used in accordance with our instructions and good plumbing practice.

**Phoenix Whirlpools Ltd. Unit 8, Leeds 27 Industrial Estate, Bruntcliffe Avenue, Morley, Leeds, LS27 0LL**  
Tel: (Sales) +44 (0)113 2012260 Fax: +44 (0)113 2012268 Email: sales@phoenix-uk.co.uk Web: www.phoenix-uk.co.uk