

PHOENIX[®]

THE RETAIL BRAND

TECHNICAL DATA SHEET

Range: Arno Furniture

Type: 50 Floor Standing 2 Door Unit & Mineral Cast Basin

Code: N080165TH N080465TH N080565TH N080765TH

Version/Date: v2 05/22

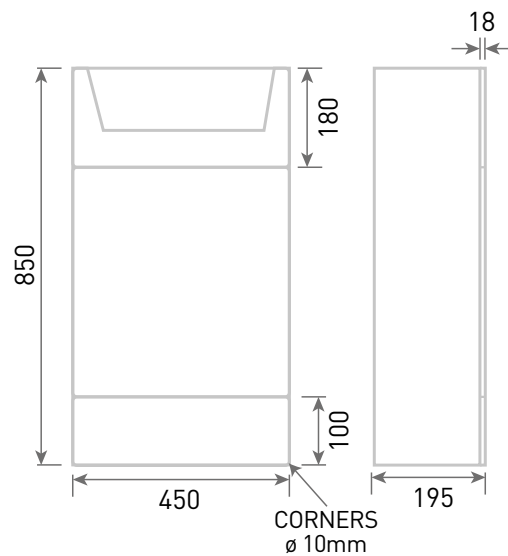
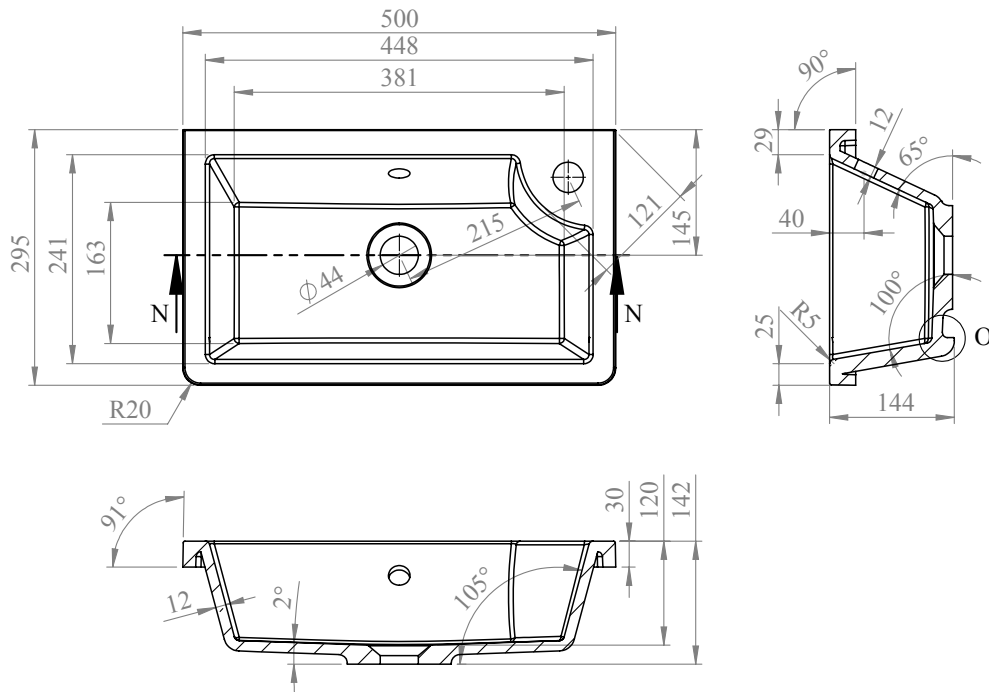

Information:

Unit Colours:



Guarantee/Aftercare: During installation extra care must be taken to avoid damaging the fittings. We provide a guarantee against faulty manufacture or materials (excluding serviceable parts), providing they have been installed, cared for and used in accordance with our instructions and good plumbing practice.

Phoenix Whirlpools Ltd. Unit 8, Leeds 27 Industrial Estate, Bruntcliffe Ave. Morley, Leeds LS27 0LL

Tel: 0113 201 2260 Email: sales@phoenix-uk.com Web: www.phoenix-uk.com

Notes: Drawings may not be to scale. All dimensions in mm unless otherwise stated. Information correct at time of printing but subject to change at any time.