

# Phoenix

DESIGNED FOR YOU

Technical Data Sheet

Range: Concealed Thermostatic Valves

Type: Twin Valve - Single Function

Code: SV044 SQ/CU/RO/TR

Version/Date: v2 02/18

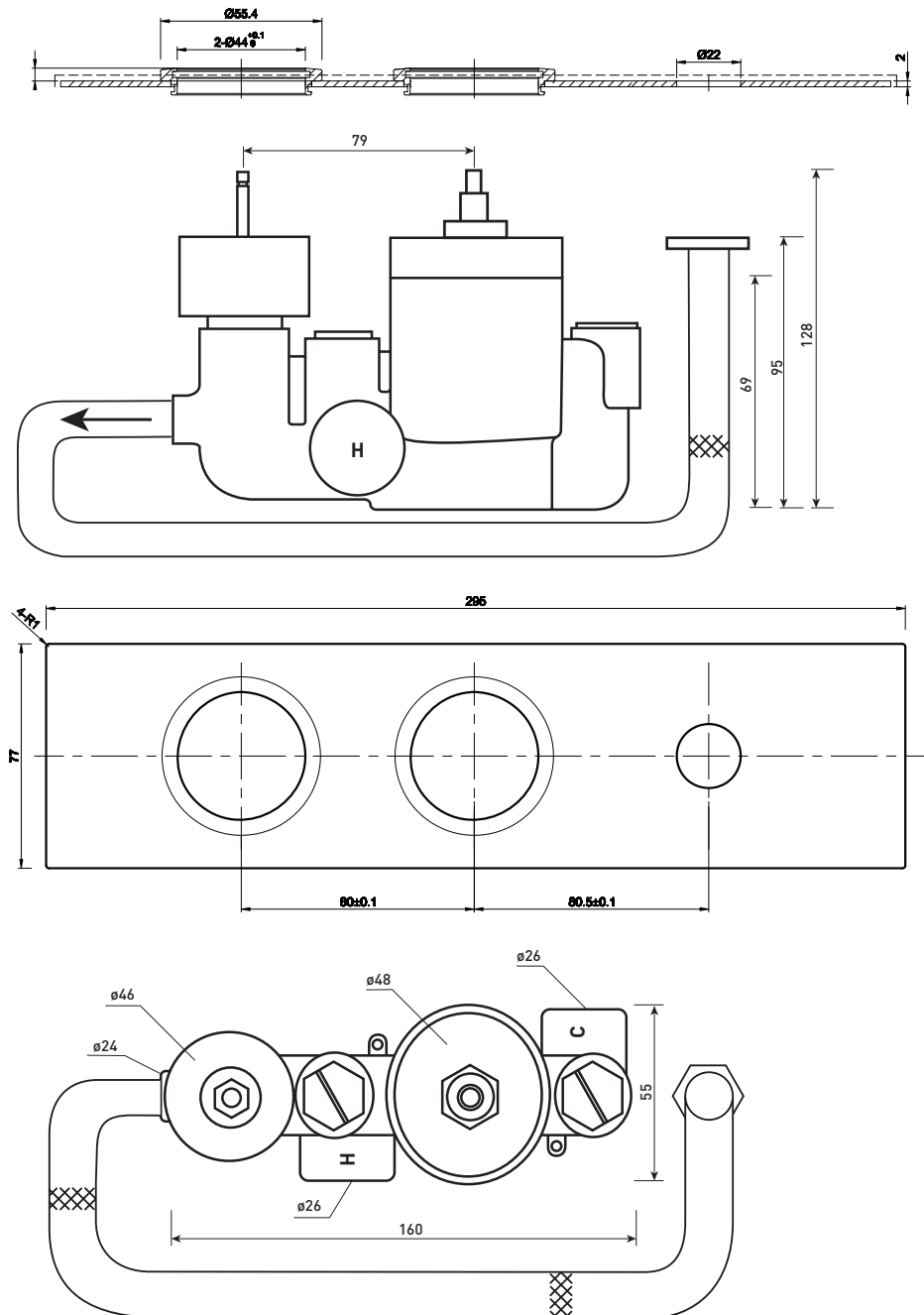

**Guarantee/Aftercare:** During installation extra care must be taken to avoid damaging the fittings. We provide a guarantee against faulty manufacture or materials (excluding serviceable parts), providing they have been installed, cared for and used in accordance with our instructions and good plumbing practice. We recommend that all brassware is installed to allow access to serviceable parts as we cannot accept responsibility in the event that access is required.

Finishes:



Chrome

Phoenix Whirlpools Ltd. Unit 8, Leeds 27 Industrial Estate, Bruntcliffe Ave. Morley, Leeds LS27 0LL

Tel: (Sales) +44 (0)113 2012260 Fax: +44 (0)113 2012268 Email: sales@phoenix-uk.co.uk Web: www.phoenix-uk.co.uk

Notes: Drawings may not be to scale. All dimensions in mm unless otherwise stated. Information correct at time of printing but subject to change at any time.