

# Phoenix

DESIGNED FOR YOU

Technical Data Sheet

Range: Accessories  
Type: A08 Series  
Code: A08003  
Version/Date: v2 01/17

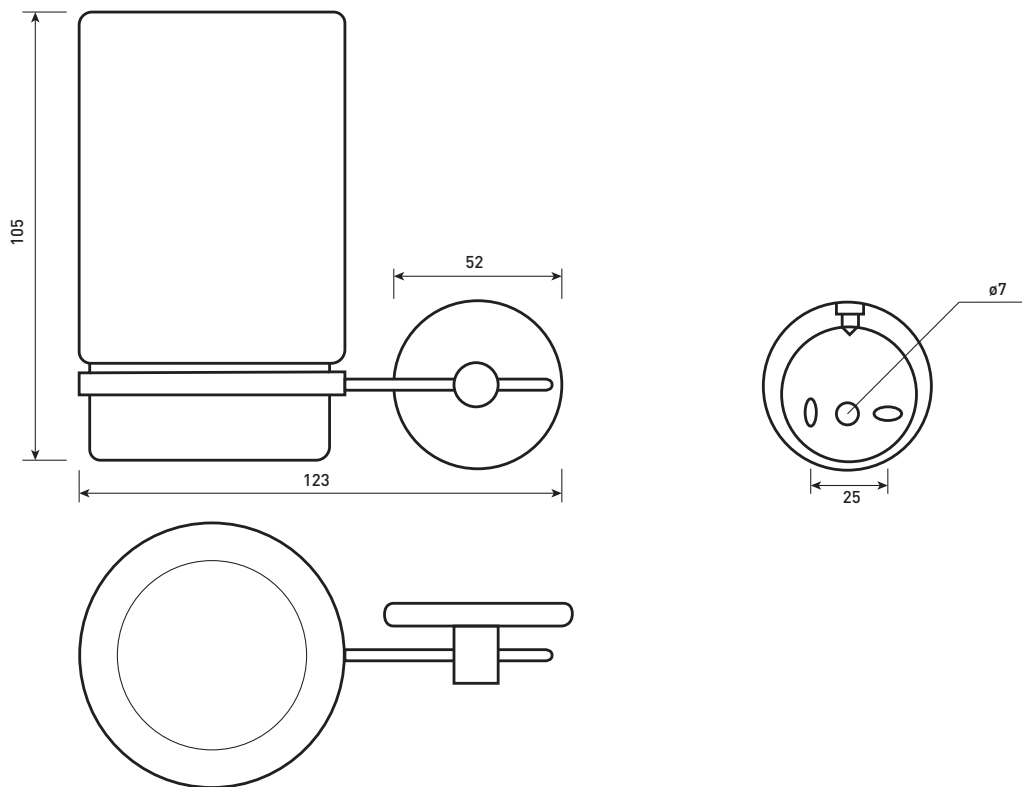

## Information:

**Guarantee/Aftercare:** During installation extra care must be taken to avoid damaging the fittings. We provide a guarantee against faulty manufacture or materials (excluding serviceable parts), providing they have been installed, cared for and used in accordance with our instructions and good plumbing practice.

## Finishes:



Chrome



White Ceramic

Phoenix Whirlpools Ltd. Unit 8, Leeds 27 Industrial Estate, Bruntcliffe Ave. Morley, Leeds LS27 0LL  
Tel: (Sales) +44 (0)113 2012260 Fax: +44 (0)113 2012268 Email: sales@phoenix-uk.co.uk Web: www.phoenix-uk.co.uk

Notes: Drawings may not be to scale. All dimensions in mm unless otherwise stated. Information correct at time of printing but subject to change at any time.